

OPERATION-WASHER

Using the Washer

WARNING

- To reduce the risk of fire, electric shock, or injury to persons, read the SAFETY INSTRUCTIONS before operating this appliance.

Operation Overview

1 Sort laundry and load the washer.

- Sort laundry by fabric type, soil level, color and load size as needed. Open the door and load items into the washer.
- If using single-use detergent packs, place pack into the drum before loading the laundry.

2 Add cleaning products.

- Add the proper amount of HE (High-Efficiency) detergent to the detergent dispenser.
- If desired, add bleach or fabric softener to the appropriate areas of the dispenser drawer.
- Do not place liquid or powdered detergent packs in the dispenser.

3 Turn on the washer.

- Press the **Power** button to turn on the washer.

4 Select a cycle.

- Turn the cycle selector knob or press the cycle buttons repeatedly until the desired cycle is selected.
- The preset wash temperature, spin speed, soil level and option settings for the selected cycle are shown.
- The **Normal** cycle must be selected in order to change its default settings.
- Pressing the **Start/Pause** button without selecting a cycle immediately starts the **Normal** cycle with the default settings.

5 Adjust settings.

- Default settings for the selected cycle can be changed, if desired, using the cycle modifier and option buttons.

- Not all modifiers and options are available on all cycles. A different chime sounds and the LED does not light up if the selection is not allowed.

6 Begin cycle.

- Press the **Start/Pause** button to begin the cycle. The door locks, and the washer agitates briefly without water to measure the weight of the load.
- If the **Start/Pause** button is not pressed within a certain time, the washer shuts off and all settings are lost.

7 End of cycle.

- When the cycle is finished, a melody sounds. Immediately remove the clothing from the washer to reduce wrinkling.
- Check around the door seal when removing the load for small items that may be caught in the seal.

NOTE

- The washer rotates the laundry in a way that allows it to use less water while still fully saturating the clothing. It is normal to be unable to see water during the wash cycle.
- If the temperature or the water level inside the machine is too high, the door will not unlock when the **Start/Pause** button is pressed, and the **Add Item** function will not be available (on applicable models). To stop a cycle and drain the water completely, turn the power off, then on, and then select **Rinse+Spin**.

Sorting Laundry

⚠ CAUTION

- Clothing or articles that are waterproof or water-resistant must be washed in the **Waterproof, Bedding, Bulky/Large, or Jumbo Wash** cycle only. (Examples include water resistant clothing, mattress covers, outdoor clothes, and plastic mats.) Failure to do so may result in personal injury or damage to the washer, clothes, walls, floor, and surrounding objects due to abnormal vibration.
- Remove the stuffing from pillows and cushions before washing the covers. Failure to do so can cause excessive vibration, resulting in damage to the washer, clothes, nearby objects, walls, and floor.

Grouping Similar Items

For the best washing results, and to reduce the possibility of damage to clothing, sort clothing into loads made up of similar items.

Mixing different fabric types and/or soil levels can result in poor wash performance, color transfer, discoloration, fabric damage or linting. Fabrics should be sorted into groups as described below.

Colors

Sort articles by color. Wash dark clothes separately from light colors or whites. Mixing dark clothes with light clothes can result in dye transfer or discoloration of the lighter clothes.

Soil Level

Wash heavily soiled clothing together. Washing lightly soiled clothing in the same load with heavily soiled clothing could result in poor wash performance for the lightly soiled clothing.

Fabric Type

Delicate articles should not be mixed with heavy or sturdy fabric types. Washing heavy fabrics with delicates can result in poor wash performance for the heavy fabrics and possible damage to the delicates.

Lint Type

Some fabrics attract and bind lint to them while others give off lint in the laundry process. Avoid mixing these lint collectors and lint producers in the same load. Mixing these fabrics will result in pilling and linting on the lint collectors. (For example, lint collector - knit sweater; lint producer - terry cloth towels.)











How to Sort Laundry

By Colors	By Soil	By Fabric	By Lint
White	Heavy	Delicates	Lint Producer
Lights	Normal	Easy Care	Lint Collector
Darks	Light	Sturdy	

Fabric Care Labels

Many articles of clothing include a fabric care label. Using the chart below, adjust the cycle and option selections to care for your clothing according to the manufacturer's recommendations.

12 OPERATION-WASHER

Category	Label	Directions
 Washing		Hand wash
		Machine wash, Normal cycle
		Perm Press/Wrinkle Resistant setting (which has a cool down or cold spray before the slower spin)
		Gentle/Delicate setting (slow agitation and/or reduced wash time)
		Do not wash
		Do not wring
Water Temperature	***	Hot
	**	Warm
	•	Cold/Cool
 Bleach Symbols		Any bleach (when needed)
		Only non-chlorine bleach (when needed)
		Do not bleach

Loading the Washer

WARNING

- Clothing or articles that are waterproof or water-resistant must be washed in the **Waterproof, Bedding, Bulky/Large, or Jumbo Wash** cycle only. (Examples include water resistant clothing, mattress covers, outdoor clothes, and plastic mats.) Failure to do so may result in personal injury or damage to the washer, clothes, walls, floor, and surrounding objects due to abnormal vibration.

General Tips

- Check and empty pockets. Paper clips, coins, matches, etc. can damage clothing and the washer.
- Close zippers and hooks, and tie drawstrings to prevent snagging or tangling of clothes.
- Pretreat heavily stained areas for best results.
- Brush off heavy soil, dust, and hair from items before washing. Excess dirt or sand can abrade other fabrics and lead to poor wash performance.

- For best performance, load clothes as shown.

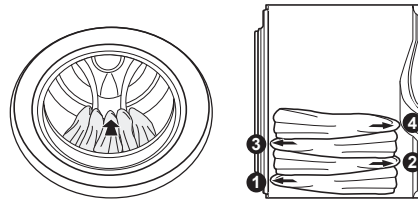

- Do not press down on items while stacking them in the drum.
- Load clothes loosely, and do not overfill the drum. Clothes need room to circulate in order to get clean.
- Combine large and small items in the drum. Load large items first. Large items should not be more than half of the total load.
- The washer can be fully loaded, but the drum should not be tightly packed with items. The door of the washer must close easily.
- The washer will not fill or operate with the door open.

Bulky Items

- Wash thick, bulky items individually. Heavy blankets, comforters, bedspreads, or pet beds can get tangled or cause an unbalanced load if combined with other items.

Small Items

- Do not wash a single small item. Add enough similar items to the load to prevent an out-of-balance load.
- Wash small, light items in a mesh bag. Small items can get caught in the impeller at the bottom of the drum, and brassiere hooks can snag on other clothing or the drum.

Adding Cleaning Products

About Detergent Use

This washer is designed for use with only HE (High-Efficiency) detergents.



- HE detergents produce fewer suds, dissolve more efficiently to improve washing and rinsing performance, and help to keep the interior of the washer clean. Using detergent that is not HE may cause oversudsing and unsatisfactory performance which could result in error codes, cycle failure, and washer damage.
- Detergents designated as HE-compatible may not provide optimal results.
- For proper wash performance, always measure detergent using the measuring device provided by the detergent manufacturer. For an average load, use less than half of the recommended maximum. Use less detergent for soft water, light soil, or smaller loads.
- Use extra care when measuring 2X and 3X concentrated detergents because even a small amount of extra detergent can lead to problems.
- Never use more than the maximum amount of detergent recommended by the manufacturer. Using too much detergent can lead to oversudsing, poor rinsing, detergent buildup in clothing, and residue buildup that can contribute to odors in the washer.

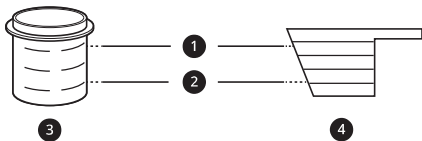

- 1 Maximum fill line
- 2 Average load fill line
- 3 Liquid detergent

- 4 Powdered detergent

Single-Use Detergent Packs

- Do not use more than one single-use detergent pack in the washer. Using too much detergent may cause oversudsing and unsatisfactory performance. Reduce detergent amount or add an extra rinse if detergent residue is left on fabrics. To add an extra rinse, select the **Extra Rinse** option.
- Place liquid or powdered detergent packs in the drum before loading laundry. Do not place detergent packs in the dispenser.

Using the Dispenser

To add cleaning products to the automatic dispenser:

- 1 Open the dispenser drawer.
- 2 Load the laundry products into the appropriate compartments.
 - Follow the manufacturer's recommendations when adding cleaning products.

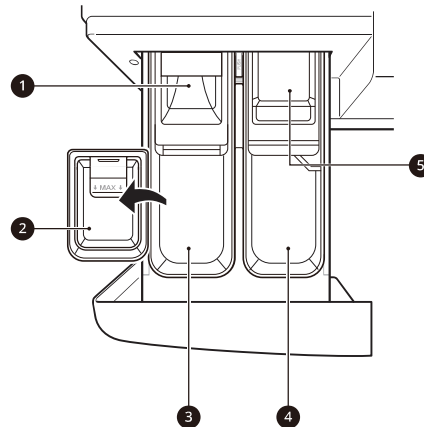

- 1 Pre-wash detergent compartment (on some models)
- 2 Liquid detergent cup
- 3 Main wash detergent compartment
- 4 Liquid fabric softener compartment
- 5 Liquid chlorine bleach compartment

14 OPERATION-WASHER

3 Gently close the detergent dispenser drawer before starting the cycle.

- Slamming the drawer closed may result in the detergent overflowing into another compartment or dispensing into the drum earlier than programmed.
- Be careful not to get a hand caught in the drawer while closing.
- It is normal for a small amount of water to remain in the dispenser compartments at the end of the cycle.

CAUTION

- Do not place or store laundry products, such as detergent, bleach, or liquid fabric softener, on top of your washer. These products can damage the washer's finish and controls.
-

Pre-wash Detergent Compartment

Add liquid or powdered detergent to this compartment when using the **Pre-wash** option. Always use HE (High-Efficiency) detergent with your washer.

- When using the **Pre-wash** option, liquid detergent for the main wash needs to be loaded in the liquid detergent cup accessory in the main wash dispenser (where applicable), to prevent it from being dispensed with the pre-wash detergent.
- The amount of detergent added for the **Pre-wash** option is 1/2 the amount recommended for the main wash cycle. For example, if the main wash cycle requires one measure of detergent, add 1/2 measure for the **Pre-wash** option.

Main Wash Detergent Compartment

This compartment holds laundry detergent for the main wash cycle. Either powdered or liquid detergent may be used in this compartment.

- The detergent is added to the load at the beginning of the cycle. Always use HE (High-Efficiency) detergent with your washer.
- Do not exceed the maximum fill line. Using too much detergent can result in detergent buildup in clothing and the washer.
- Liquid or powdered color-safe bleach may be added to the main wash compartment with detergent of the same type. Do not mix liquids and powders
- If the dispenser has a liquid detergent cup and insert:
 - Make sure they are in place when using liquid detergent.

- Make sure to remove them when using powdered detergent. Powdered detergent will not dispense with the liquid detergent cup and insert in place.
- If you use a detergent that does not dissolve easily or a detergent with high viscosity, it will leave a residue and clog the dispenser.

Liquid Bleach Compartment

This compartment holds liquid bleach, which is dispensed automatically at the proper time during the wash cycle. The dispenser is activated twice to ensure complete dispensing of the bleach. Any liquid remaining in the dispenser at the end of the cycle is water, not bleach.

WARNING

- Do not mix chlorine bleach with ammonia or acids such as vinegar or rust/scale remover. Mixing chemicals like these can produce a lethal gas, resulting in severe injury or death.
-

NOTE

- Do not add powdered bleach to this compartment. The bleach compartment is designed to dispense liquid chlorine bleach only. Powdered or liquid color-safe bleach will not dispense properly.
 - Follow the manufacturer's recommendations when adding bleach. Never add more than one cup, and do not exceed the maximum fill line or the bleach may be dispensed immediately and damage fabrics. Using too much bleach can also damage fabrics.
 - Never pour undiluted liquid chlorine bleach directly onto the load or into the drum. Fabric damage can occur.
 - Do not use color-safe bleach or oxygen bleach in the same cycle with liquid chlorine bleach.
-

Fabric Softener Compartment

This compartment holds fabric softener, which is automatically dispensed during the final rinse cycle. Either powdered or liquid fabric softener may be used.

- Do not exceed the maximum fill line. Using too much fabric softener may stain clothes or cause buildup on fabrics or in the washer.
- Dilute concentrated fabric softeners with warm water.
- Never pour fabric softener directly onto the load or into the drum.

Control Panel

Control Panel Features for the Washer

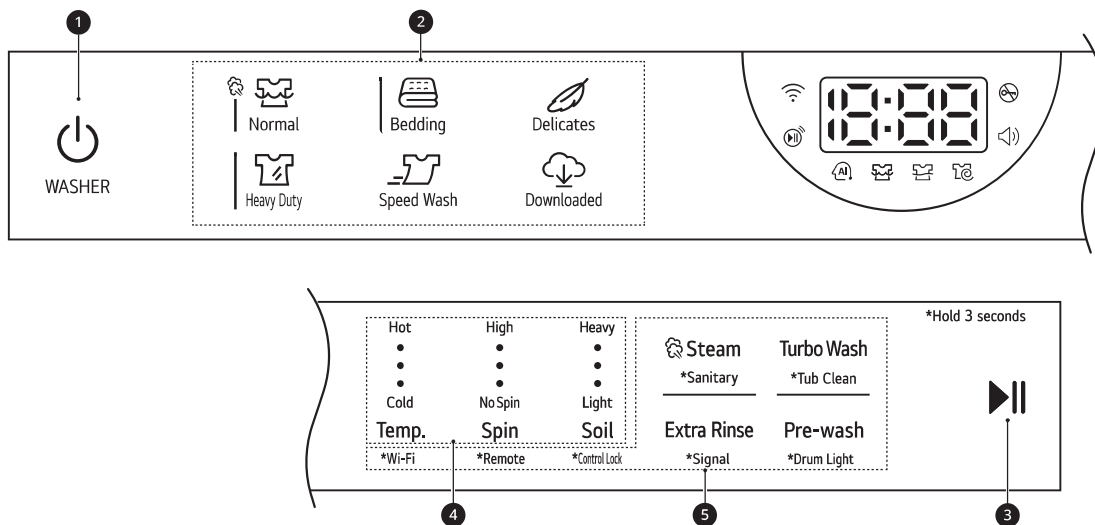

1 Power On/Off Button

- Press this button to turn the washer on or off.
- Pressing this button during a cycle will cancel that cycle and any load settings will be lost.
- The door will unlock after a brief pause.

NOTE

- If there is any water remaining in the drum after the washer shuts off, it will drain after a delay. The washer can be restarted at any time before the drain begins. However, once the water begins to drain, all functions will be suspended until the water has been completely drained and the washer shuts off.

2 Cycles

- Press a button to select the desired cycle.
- Once the desired cycle has been selected, the standard presets will appear in the display. These settings can be adjusted using the **Cycle Modifier buttons** at any time before starting the cycle.

3 Start/Pause Button

- Press and hold this button to start the selected cycle.
- If the washer is running, use this button to pause the cycle without losing the current settings.

NOTE

- If the **Start/Pause** button is not pressed to start the selected cycle, after a delay the washer automatically turns off and all cycle settings are lost. Any water remaining in the drum will be drained.

4 Cycle Modifier Buttons

- Use these buttons to adjust the wash temperature, spin speed and soil level settings for the selected cycle.
- The current settings are shown in the display.
- Press the button for that option to select other settings.

5 Option and Extra Function Buttons

16 OPERATION-WASHER

- These buttons allow you to select additional cycle options. Certain buttons also allow you to activate special functions by pressing and holding the button for **3 seconds**.

Remote Start

Use a smartphone to control your washer remotely.

- For more information, see **SMART FUNCTIONS** in this manual.

Wi-Fi

When the washer is connected to a home Wi-Fi network, the  icon on the control panel is lit.

- To connect the washer to the **LG ThinQ** application, press and hold the **Temp.** button for 3 seconds.

Time and Status Display

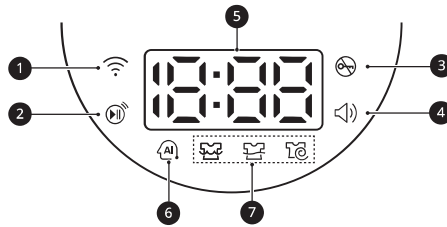

1 Wi-Fi Indicator

- This indicator is lit when the product is connected to a home Wi-Fi network.

2 Remote Start Indicator

- This indicator lights up when the **Remote Start** feature is activated.

3 Door Lock Indicator

- This indicator lights up when the cycle starts and the door is locked.
- The indicator light stays on until the cycle is paused, stopped or has finished.

4 Signal Indicator

- This indicator lights up when the end-of-cycle and button tones are turned on.

5 Estimated Time Remaining

- When a cycle is selected, the default time for that cycle is displayed. This time will change as modifiers or options are selected.
- If the display shows -| --, then the time will be displayed after the load sensing has detected the load size.
- The time shown is only an estimate. This time is based on normal operating conditions. Several external factors (load size, room temperature, incoming water temperature, etc.) can affect the actual time.

NOTE

- Once the **Start/Pause** button is pressed, the washer will measure the size of the load. The estimated time may change once the load size has been measured.
-

6 AI DD Indicator

- This feature offers optimized washing by detecting the load size and laundry characteristics. The indicator lights up when the **Normal** cycle is selected with a **Warm** wash temperature setting.

NOTE

- The **AI DD** functionality may vary depending on the environment and model.
-

7 Cycle Status Indicators

- These LEDs will blink when a cycle is selected to indicate which stages will run.
- When a cycle is running, the LED for the active stage will blink, and the LEDs for the remaining stages will remain steady. Once a stage is complete, the LED will turn off. If a cycle is paused, the active stage LED will stop blinking.

Wash Cycles

The wash cycles are designed for specific types of wash loads. Select the cycle that best matches the load contents for maximum wash performance and fabric care. See **Sorting Laundry** section for best results, and follow the fabric care labels on your garments. For a guide to fabric care symbols, see **Sorting Laundry** section.

Cycle Guide

Turn the knob or press the button to select the desired cycle. When you select a wash cycle, the light for the corresponding wash cycle will turn on.

NOTE

- Whenever load weights are mentioned, assume **1 lb (0.45 kg)** = 1 thick bath towel (dry).

Hot • • • Cold Temp.	High • • • No Spin Spin	Heavy • • • Light Soil	• Temperature: Cold > Cool > Warm > Very Warm > Hot • Spin: No Spin > Low > Medium > Medium High > High • Soil: Light > Limited > Normal > Moderate > Heavy
-------------------------------------	--	---------------------------------------	--

Cycle	Normal	
Description	Use to wash all normal items such as cotton, linen, shirts, jeans or mixed loads, except delicate fabrics such as wool or silk. <ul style="list-style-type: none"> • Pressing the Start/Pause button without selecting a cycle will cause the Normal cycle to begin immediately, using the default settings. 	
Wash Temp.	Default: Warm	Available: All
Spin Speed	Default: Medium High	Available: High, Medium High, Medium, Low
Soil Level	Default: Normal	Available: All

Cycle	Bedding	
Description	Suitable for washing blankets or bulky items which have difficulty absorbing water, such as pillows, blankets, comforters, sheets or pet bedding. <ul style="list-style-type: none"> • Do not use this cycle to wash a mixed load of bedding and non-bedding items. • Do not mix large/bulky items with smaller articles of clothing. • Do not wash excessively large items. If large/bulky items do not fit easily into the tub, there may not be enough room for them to move during washing. 	
Wash Temp.	Default: Warm	Available: Very Warm, Warm, Cool, Cold
Spin Speed	Default: Medium	Available: Medium, Low, No Spin
Soil Level	Default: Normal	Available: All

Cycle	Delicates	
Description	Suitable for washing dress shirts/blouses, nylons, lingerie, or sheer and lacy clothes which can easily be damaged. (less than 8 lb (3.63 kg))	
Wash Temp.	Default: Cool	Available: Warm, Cool, Cold
Spin Speed	Default: Medium	Available: Medium, Low, No Spin

Cycle	Delicates	
Soil Level	Default: Normal	Available: All

Cycle	Heavy Duty	
Description	Suitable for washing heavily soiled laundry, such as cotton fabrics, using more powerful wash motions. <ul style="list-style-type: none"> When washing large loads, there will be brief periods of 2 minutes or more without agitation. These soak periods are part of the cycle's design, and are normal. 	
Wash Temp.	Default: Warm	Available: All
Spin Speed	Default: High	Available: High, Medium High, Medium, Low
Soil Level	Default: Heavy	Available: All

Cycle	Speed Wash	
Description	Quickly washes lightly soiled clothing and small loads. For high wash and rinse efficiency, wash small loads of 2-3 lightly soiled garments. (less than 3 lb (1.36 kg)) <ul style="list-style-type: none"> Use very little detergent in this cycle. To add an extra rinse, use the Extra Rinse option. 	
Wash Temp.	Default: Very Warm	Available: Very Warm, Warm, Cool, Cold
Spin Speed	Default: High	Available: All
Soil Level	Default: Light	Available: All

Cycle	Downloaded (Rinse+Spin)	
Description	Use a smartphone to download a specialized cycle to this cycle position. <ul style="list-style-type: none"> The default cycle is Rinse+Spin. This cycle is also available for download. Refer to the LG ThinQ application to see the cycles available for download. 	
Wash Temp.	Default: Cool	Available: Cool
Spin Speed	Default: Medium High	Available: All
Soil Level	Default: -	Available: -

Available Options

† This option is automatically included in the cycle and cannot be deselected.

NOTE

- If the **Turbo Wash™** option is on, you cannot set the spin level to **No Spin**.

Cycle	Steam	Turbo Wash™	Extra Rinse	Pre-wash
Normal	●	●†	●	●
Bedding	●	●	●	●

20 OPERATION-WASHER

Cycle	Steam	Turbo Wash™	Extra Rinse	Pre-wash
Delicates			●	●
Heavy Duty	●	●†	●	●
Speed Wash		●	●	
Downloaded default: Rinse+Spin			●	

Cycle Modifiers

About Modifier Buttons

Each cycle has default settings that are selected automatically. You can also customize these settings using the cycle modifier buttons.

- Repeatedly press the button for the desired modifier until the indicator light for the desired setting is lit.
- The washer automatically adjusts the water level for the type and size of wash load for best results and maximum efficiency.
- This is a high-efficiency washer, and the water levels may be much lower than you expect. This is normal, and cleaning/rinsing performance will not be compromised.

Hot	High	Heavy
•	•	•
•	•	•
•	•	•
Cold	No Spin	Light
Temp.	Spin	Soil

NOTE

- The LED next to the setting lights up when the setting is selected.
- To protect your garments, not every wash temperature, spin speed, soil level, or option is available with every cycle.
- A chime will sound twice and the LED will not light if the desired setting is not allowed for the selected cycle.
- Follow the fabric care labels on the garment for best results.

Temp.

Make sure the wash temperature is suitable for the type of load you are washing.

- Press the **Temp.** button repeatedly to select the wash and rinse temperature combination for the selected cycle.
- All rinses use unheated cold water.
- Cold rinses use less energy. The actual cold rinse temperature depends on the temperature of the cold water at the faucet.

Spin

Higher spin speeds extract more water from clothes, reducing drying time and saving energy.

- Press the **Spin** button repeatedly until the desired speed is selected.

- Some fabrics, such as delicates, require a slower spin speed.

Soil

Adjusting the soil level setting will modify the cycle times and/or wash actions.

- Press the **Soil** button repeatedly until the desired soil level is selected.
- The **Heavy** soil setting may increase cycle times. The **Light** soil setting may decrease cycle times.

Options and Extra Functions

Your washer includes several additional cycle options to customize cycles to meet your individual needs.

- Select the desired option after selecting the desired cycle and settings.

NOTE

- The LED for the option will light when the option is selected.
- To protect your garments, not every option is available with every cycle.
- A chime will sound twice and the LED will not light if the selected option is not allowed for the selected cycle.

Special Cycles

Sanitary

This cycle washes clothes at a high temperature.

Tub Clean

This is a special cycle designed to clean the inside of the washer.

Steam

Adding this option to a wash cycle helps provide superior cleaning performance. Using steam gives fabrics the cleaning benefits of a very hot wash.

- Steam may not be clearly visible during steam cycles. This is normal. Too much steam could damage clothing.
- Do not use steam with delicate fabrics such as wool and silk, or easily discolored fabrics.

⚠ WARNING

- Do not touch the door during steam cycles. The door surface can become very hot and can cause severe burns. Allow the door lock to release before opening the door.
 - Do not attempt to override the door lock mechanism or reach into the washer during a steam cycle. Steam can cause severe burns.
-

Turbo Wash™

Adding this option reduces the cycle time while still providing similar wash performance to the same cycle without **Turbo Wash™**.

NOTE

- This option cannot be used with all cycles.
 - This option defaults to on for **Normal** and **Heavy Duty** wash cycles.
-

Extra Rinse

This option adds an extra rinse to the selected cycle. Use this option to help ensure the removal of detergent or bleach residue from fabrics.

- Press the **Extra Rinse** button to add additional rinses to the cycle.

Using the Pre-wash Option

This option adds a pre-wash (for about **15 - 17 minutes**) for improved cleaning of heavily soiled or stained clothing.

NOTE

- If you select **Pre-wash** after putting the detergent directly in the drum, the detergent may be washed away, reducing the washing performance.
-

Control Lock

Use this function to disable the controls. This function can prevent children from changing cycles or operating this washer.

NOTE

- The function does not lock the door.

- Once this function is set, all buttons are locked except the **Power** button.
 - When the controls are locked, **⏸** and the remaining time are alternately shown on the display during the wash cycle.
 - Turning off the power will not reset this function. You must deactivate this function before you can access any other options and functions.
-

Locking/Unlocking the Control Panel

- 1** Turn on the power.
 - 2** Press and hold the **Soil** button for 3 seconds to activate/deactivate this function.
- When the function is deactivated, a chime will sound and the remaining time for the current cycle will reappear on the display.

Signal

The washer plays a melody when the wash cycle is finished. The buttons make a sound each time a button is pressed. Use this button to turn the melody and button tones on or off.

- To turn the function on/off, press and hold the **Extra Rinse** button for 3 seconds.

Drum Light

The drum is equipped with a white LED light that illuminates when the washer is turned on. This light automatically turns off when the door is closed and the cycle starts.

- Press and hold the **Pre-wash** button for 3 seconds during the cycle to turn on the drum light.
- The drum light will turn off automatically after 4 minutes.

OPERATION-DRYER

Using the Dryer

⚠ WARNING

- To reduce the risk of fire, electric shock, or injury to persons, read the SAFETY INSTRUCTIONS before operating this appliance.

Operation Overview

- 1** Clean the Lint Filter.
 - If the lint filter has not already been cleaned, lift out the filter and remove the lint from the last load. This will help ensure the fastest and most efficient drying performance. Make sure to reinstall the filter, pressing down until it clicks firmly into place.
- 2** Load the Dryer.
 - Load the dryer with the wet laundry from the washer. If the load is extra large, you may need to divide it into smaller loads for proper performance and fabric care.
- 3** Turn on the Dryer.
 - Press the **Power** button to turn on the dryer. The cycle LEDs will illuminate and a chime will sound.
- 4** Select a Cycle.
 - Press a cycle button to select a cycle. The preset temperature, dry level, and option settings for that cycle will be shown.
- 5** Adjust Settings.

Default settings for the selected cycle can now be changed, if desired, using the cycle modifier and option buttons.

 - Not all modifiers and options are available on all cycles. A different chime will sound and the LED will not come on if the selection is not allowed.
- 6** Begin Cycle.
 - Press the **Start/Pause** button to begin the cycle. The cycle can be paused at any time either by opening the door or by pressing the **Start/Pause** button. If the cycle is not

restarted within 14 minutes of being paused, the dryer will shut off and the settings will be lost.

7 End of Cycle

- When the cycle is finished, the chime will sound. Immediately remove your clothing from the dryer to reduce wrinkling. If **Wrinkle Care** is selected, the dryer will tumble briefly every few minutes to help prevent wrinkles from setting in the clothes.

Check the Lint Filter Before Every Load

Always make sure the lint filter **1** is clean before starting a new load; a clogged lint filter will increase drying time. To clean, pull the lint filter straight up and roll any lint off the filter with your fingers. Push the lint filter firmly back into place. See **Regular Cleaning** for more information.

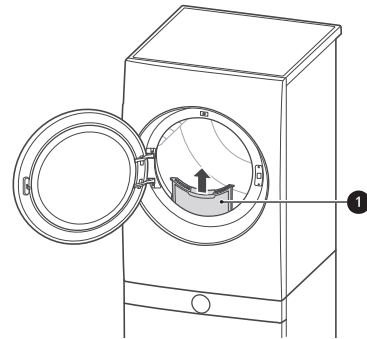

Always ensure the lint filter is properly installed before running the dryer. Running the dryer with a loose or missing lint filter will damage the dryer and articles in the dryer.

Loading the Dryer

General Tips

- Combine large and small items in the same load.
- Close zippers, hooks and drawstrings to prevent these items from snagging or tangling on other clothes.

NOTE

- Damp clothes will expand as they dry. Do not overload the dryer; clothes require room to tumble and dry properly.

Grouping Similar Items

For the best drying results, and to reduce the possibility of damage to clothing, sort clothes into loads that can be dried with the same drying cycle.

Different fabrics have different care requirements, and some fabrics will dry more quickly than others.

Woolen Items

Always follow fabric care labels before drying woolen items in a dryer. After the cycle, the items may still be damp. Do not repeat the cycle. Pull the items to their original shape if needed and lay them flat to finish drying.

Woven and Loopknit Materials

Some woven and loopknit materials may shrink, depending on quality.

Permanent Press and Synthetics

Do not overload your dryer. Take out permanent press items as soon as the dryer stops to reduce wrinkles.

Baby Clothes and Nightgowns

Always check the manufacturer's instructions.

Rubber and Plastics

Do not dry any items made from or containing rubber or plastics such as:

- Aprons, bibs and chair covers
- Curtains and tablecloths
- Bath mats

Fiberglass







Do not dry fiberglass articles in your dryer. Glass particles left in the dryer could be picked up by your clothes the next time you use the dryer and irritate your skin.





Fabric Care Labels

Sort and dry laundry according to care labels, size, and fabric type. Do not overload the dryer. This will save energy and time and give the best drying performance.

Fabric Care Labels

Many articles of clothing include a fabric care label. Using the chart below, adjust the cycle and option selections to care for your clothing according to the manufacturer's recommendations.

Tumble Dry	
Label	Directions
	Dry
	Normal
	Permanent Press / Wrinkle Resistant
	Gentle / Delicate
	Do not tumble dry
	Do not dry (used with do not wash)

Heat Setting	
Label	Directions
	High
	Medium
	Low
	No Heat / Air

Control Panel

Control Panel Features for the Dryer

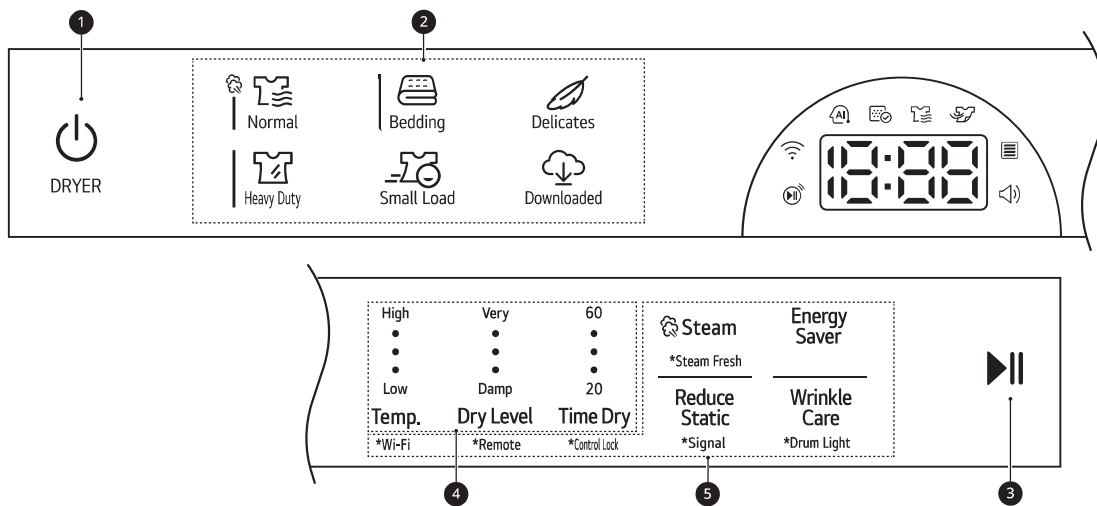

1 Power Button

- Press the button to turn the appliance on. Press again to turn the appliance off.

NOTE

- Pressing the **Power** button during a cycle will cancel that cycle and any load settings will be lost.

2 Cycles

- Press a button to select the desired cycle. Once the desired cycle has been selected, the standard presets will be shown in the display.

3 Start/Pause Button

- Press and hold this button to start the selected cycle. If the appliance is running, use this button to pause the cycle without losing the current settings.

NOTE

- If you do not press the **Start/Pause** button to resume a cycle within 14 minutes, the appliance turns off automatically and all cycle settings are lost.

4 Cycle Modifier Buttons

- Press these buttons to select additional cycle options. Press and hold any button marked with an asterisk for 3 seconds to activate a special function.

5 Extra Options and Functions

- Use these buttons to select the desired options for the selected cycle. Not all options are available for each cycle.
- **Remote Start**
 - With the **LG ThinQ** app, you can use a smartphone to control your appliance remotely.
- **Wi-Fi**
 - Press and hold the **Temp.** button for 3 seconds to initiate the connection of the appliance to the **LG ThinQ** application.

Time and Status Display

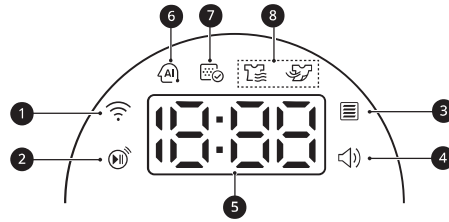

1 Wi-Fi Indicator

- This indicator is lit when the product is connected to a home Wi-Fi network.

2 Remote Start Indicator

- This indicator lights up when the Remote Start feature is activated.

3 Flow Sense Indicator

- The Flow Sense duct blockage sensing system detects and alerts you to blockages in the ductwork that reduce exhaust flow from the dryer. Maintaining a clean exhaust system improves operating efficiency and helps minimize service calls, saving you money.

4 Signal Indicator

- This indicator lights up when the end-of-cycle and button tones are turned on.

5 Estimated Time Remaining

- When a drying cycle is selected, the estimated drying time for the selected cycle is displayed. This time will change if you select extra options for the cycle.
- The cycle time on Sensor Dry cycles may fluctuate as the appliance recalculates drying time for optimal results.



6 AI Sensor Dry Indicator

- This feature optimizes drying times and temperatures by detecting the laundry's characteristics. The indicator lights up when the **Normal** cycle is selected with the **Normal** dry level, except when the **Energy Saver** option is turned on.

7 Lint Filter Status Indicator

-  lights up at the beginning of the cycle to remind you to check the lint filter. It also lights up if the lint filter needs to be cleaned or is missing.
 - If the lint filter is not inserted, the icon will light up and the appliance will not operate.

8 Cycle Status Indicators

-  lights up when the appliance is in the drying stage.
-  lights up when the appliance is in the cool down stage.

Dry Cycles

Cycle Guide

The appliance automatically sets the dryness level and temperature at the recommended setting for each cycle. The estimated time remaining will be shown in the display.

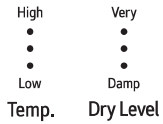

- **Temperature:** Low > Medium Low > Medium > Medium High > High
- **Dry Level:** Damp > Less > Normal > More > Very

Cycle	Normal	
Description	Use this cycle for drying all normal items such as cotton, linen, shirts, jeans or mixed loads, except delicate fabrics such as wool or silk.	
Temp.	Default: Medium High	Available: Medium High
Dry level	Default: Normal	Available: All

Cycle	Bedding	
Description	Use this cycle for drying blankets or bulky items such as pillows, blankets, comforters, sheets or pet bedding.	
Temp.	Default: Medium	Available: Medium
Dry level	Default: Normal	Available: Very, More, Normal

Cycle	Delicates	
Description	Use this cycle for drying dress shirts/blouses, nylons, lingerie, or sheer and lacy clothes which can easily be damaged.	
Temp.	Default: Medium Low	Available: Medium Low
Dry level	Default: Normal	Available: All

Cycle	Heavy Duty	
Description	Use this cycle for drying heavy-duty clothes like jeans or garments that need extra drying.	
Temp.	Default: High	Available: High
Dry level	Default: Normal	Available: All

Cycle	Small Load	
Description	Use this cycle for drying light or small items. (up to 3 items)	
Temp.	Default: High	Available: High
Dry level	Default: Normal	Available: Very, More, Normal

Cycle	Downloaded (Perm. Press)	
Description	Use a smartphone to download a specialized cycle to this cycle position. <ul style="list-style-type: none"> • The default cycle is Perm. Press. This cycle is also available for download. • Refer to the LG ThinQ application to see the cycles available for download. 	
Temp.	Default: Medium	Available: Medium
Dry level	Default: Normal	Available: All

Available Options

† This option is automatically included in the cycle and can be deselected.

NOTE

- The **Energy Saver** option is set to on by default. If you turn on the dryer and set the **Energy Saver** option to off, the **Energy Saver** option is turned off when you turn on the dryer.

Cycle	Steam	Winkle Care	Reduce Static	Energy Saver
Normal		●	●	●†
Bedding	●		●	
Delicates		●	●	
Heavy Duty	●	●	●	
Small Load		●		
Downloaded default: Perm. Press	●	●	●	

Cycle Modifiers

About Modifier Buttons

Each cycle has default settings that are selected automatically. Customize these settings using the cycle modifier buttons. Press the button for the desired modifier to open the modifier's screen.

High	Very	60
•	•	•
•	•	•
•	•	•
Low	Damp	20
Temp.	Dry Level	Time Dry

Temp.

Use this button to adjust the temperature setting. This allows precise care of fabrics and garments. Press the **Temp.** button repeatedly to scroll through available settings.

Dry Level

Use this button to select the dryness level for the cycle. Press the **Dry Level** button repeatedly to scroll through available settings.

- The appliance will automatically adjust the cycle time according to the selected dryness level. Selecting **More** or **Very** will increase the cycle time, while **Less** or **Damp** will decrease the cycle time.
- Use a **Less** or **Damp** setting for items that you wish to iron.

Time Dry

Use this button to manually select the drying time, from 20 to 60 minutes, in 10-minute increments.

- Use this for small loads or to remove wrinkles.

Options and Extra Functions

Your dryer includes several additional cycle options to customize cycles to meet your individual needs.

Select the desired option after selecting the desired cycle and settings.

NOTE

- The LED for the option will light up when the option is selected.
- To protect your garments, not every option is available with every cycle.

- A chime will sound twice and the LED will not light up if the selected option is not allowed for the selected cycle.

Steam

Adding the **Steam** option to a dry cycle helps reduce wrinkles and odor in fabrics.

⚠ WARNING

- Do not touch the door during steam cycles. The door surface can become very hot.
- Do not attempt to reach into the dryer during a steam cycle. Steam can cause severe burns.

NOTE

- Steam may not be clearly visible during steam cycles. This is normal.
- Do not use steam with delicate fabrics such as wool, silk, or easily discolored fabrics.
- When the filter/duct is clogged, this option may not have optimal results.
- When the steam function is operating, the drum will stop to allow steam to stay in the drum.

Steam Fresh

This cycle uses the power of steam to quickly reduce wrinkles and odors in fabrics. It brings new life to wrinkled clothes that have been stored for an extended time and makes heavily wrinkled clothes easier to iron. It can also be used to help reduce odors in fabrics.

- 1 Press the **Power** button to turn on the dryer.
- 2 Press and hold the **Steam** button for 3 seconds.
- 3 To add an option, select **Wrinkle Care**.
- 4 Press **Start/Pause** to start the cycle.

NOTE

- Steam may not be clearly visible during the steam cycles. This is normal.

NOTE

- Do not use **Steam Fresh** with items such as wool, wool blankets, leather jackets, silk, wet clothes, lingerie, foam products, or electric blankets.
-

Wrinkle Care

Selecting this option will tumble the load periodically for up to 3 hours after the selected cycle, or until the door is opened. This is helpful in preventing wrinkles when you are unable to remove items from the dryer immediately.

Press the **Wrinkle Care** button before you start a drying cycle.

NOTE

- When the option is set, a rectangle with a dashed line and End appears on the display until the feature is off.
 - When the option is set, only the **Power** button works after the drying cycle ends.
 - When a drying cycle is running, pause the cycle first to set the option.
 - Always turn off the appliance before unloading the clothes.
-

Reduce Static

This option injects steam late in the drying cycle to reduce the static electricity caused by dry fabrics rubbing together.

Energy Saver

This option helps to reduce the energy consumption of the **Normal** cycle, depending on the load size. When the **Energy Saver** option is selected, the cycle begins with an air dry section and the drying time is increased.

Control Lock

Use this function to disable the controls. This function can prevent children from changing cycles or operating this dryer.

NOTE

- The function does not lock the door.

- Once this function is set, all buttons are locked except the **Power** button.
 - When the controls are locked, **CL** and the remaining time are alternately shown on the display during the dry cycle.
 - Turning off the power will not reset this function. You must deactivate this function before you can access any other options and functions.
-

Locking/Unlocking the Control Panel

- 1 Turn on the power.
 - 2 Press and hold the **Time Dry** button for 3 seconds to activate/deactivate this function.
- When the function is deactivated, a chime will sound and the remaining time for the current cycle will reappear on the display.

Signal

The dryer plays a melody when the dry cycle is finished. The buttons make a sound each time a button is pressed. Use this button to turn the melody and button tones on or off.

- To turn the function on/off, press and hold the **Reduce Static** button for 3 seconds.

Drum Light

The drum is equipped with a white LED light that illuminates when the dryer is turned on. This light automatically turns off when the door is closed and the cycle starts.

- Press and hold the **Wrinkle Care** button for 3 seconds during the cycle to turn on the drum light.
- The drum light will turn off automatically after 4 minutes.

SMART FUNCTIONS

Using LG ThinQ Application

The **LG ThinQ** application allows you to communicate with the appliance using a smartphone.

LG ThinQ Application Features

- **Remote Start**
 - Control the appliance remotely from the **LG ThinQ** application.
- **Downloaded**
 - Download new and specialized cycles that are not included in the standard cycles on the appliance. Once cycle download is completed in the appliance, the product keeps the downloaded cycle until a new cycle is downloaded.
- **Cloud Cycle**
 - The Cloud cycles include many cycles which are started from the Cloud and offer various options. However, the downloaded cycle is deleted from the appliance when the power is turned off.
- **Tub Clean Coach (Washer)**
 - Find out how many cycles remain before it is time to run the **Tub Clean** cycle.
- **Venting Tips (Dryer)**
 - Access tips for optimizing dryer ventilation.
- **Energy Monitoring**
 - Keep track of the washer's power consumption and how it is affected by your selected wash cycles and options.
- **Smart Diagnosis™**
 - This function provides useful information for diagnosing and solving issues with the appliance based on the pattern of use.
- **Push Alerts**
 - When the cycle is complete or the appliance has problems, you will receive a push message.
- **Settings**
 - Set various options on the appliance and in the application.

NOTE

- If you change your wireless router, Internet service provider, or password, delete the connected appliance from the **LG ThinQ** application and connect it again.

- This information is current at the time of publication. The application is subject to change for product improvement purposes without notice to users.

Before Using LG ThinQ Application

- 1 Check the distance between the appliance and the wireless router (Wi-Fi network).
 - If the appliance is too far from the router, the signal strength becomes weak. It may take a long time to connect or installation may fail.
- 2 Turn off the **Mobile data** or **Cellular Data** on your smartphone.

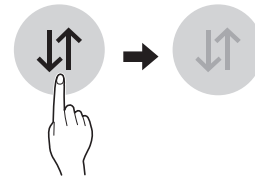

- 3 Connect your smartphone to the wireless router.

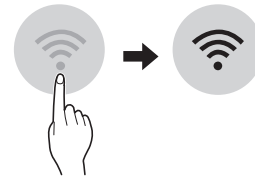

NOTE

- To verify the Wi-Fi connection, check that the  icon on the control panel is lit.
- The appliance supports 2.4 GHz Wi-Fi networks only. To check your network frequency, contact your Internet service provider or refer to your wireless router manual.
- **LG ThinQ** is not responsible for any network connection problems or any faults, malfunctions, or errors caused by network connection.
- If the appliance is having trouble connecting to the Wi-Fi network, it may be too far from the router. Purchase a Wi-Fi repeater (range extender) to improve the Wi-Fi signal strength.
- The Wi-Fi connection may not connect or may be interrupted because of the home network environment.

NOTE

- The network connection may not work properly depending on the Internet service provider.
- The surrounding wireless environment can make the wireless network service run slowly.
- If the appliance cannot be registered due to problems with the wireless signal transmission, unplug the appliance and wait about a minute before trying again.
- If the firewall on your wireless router is enabled, disable the firewall or add an exception to it.
- The wireless network name (SSID) should be a combination of English letters and numbers. (Do not use special characters.)
- Smartphone user interface (UI) may vary depending on the mobile operating system (OS) and the manufacturer.
- If the security protocol of the router is set to **WEP**, network setup may fail. Change the security protocol (**WPA2** is recommended) and connect the product again.

Installing the LG ThinQ Application

Search for the **LG ThinQ** application from the Google Play Store or Apple App Store on a smartphone. Follow instructions to download and install the application.

Using the Washer/Dryer Remotely

Remote Start

Use a smartphone to control your appliance remotely. You can also monitor your cycle operation so you know how much time is left in the cycle.

Using Remote Start

- 1** Load the laundry.

- 2** Press the **Power** button.

- 3** Press and hold the **Remote** button for 3 seconds to enable the remote control function.

- 4** Start a cycle from the **LG ThinQ** application on your smartphone.

NOTE

- Once this function is enabled, you can only start a cycle from the **LG ThinQ** smartphone application. If the cycle is not started, the appliance will wait to start the cycle until it is turned off remotely from the application or this function is disabled.
- If the door has been opened, you cannot start a cycle remotely.

Disabling Remote Start Manually

When the function is activated, press and hold the **Remote** button for 3 seconds.

Downloaded Cycle

You can download new and specialized cycles that are not included in the standard cycles on the appliance.

Appliances that have been successfully connected can download a variety of specialty cycles specific to the appliance.

Once cycle download is completed in the appliance, the product keeps the downloaded cycle until a new cycle is downloaded.

NOTE

- Only one downloaded cycle can be stored on the appliance at a time.

Cloud Cycle

Use the **LG ThinQ** app to start cycles with various options. Cloud cycles are deleted from the appliance once the power is turned off.

Downloaded and Cloud Cycles for the Washer

Check the **LG ThinQ** app for available Downloaded and Cloud cycles for your model.

Cycle Name	Description
Allergiene	Powerful, high-temp cycle to reduce certain allergens

Cycle Name	Description
Beachwear	Optimized for beachwear
Blanket	Cleans blankets which are used every day. Do not use for wool blankets.
Bright Whites	Bright whites only
Collars and Cuffs	Washes collars and cuffs using a high temperature for effective stain removal.
Color Care	Keeps colors from fading
Delicate Dresses	Cleans lightly stained cocktail dresses with care
Denim	Special cycle for jeans
Spin Only	For spinning dry handwashables.
Full Load Wash	Optimized wash settings for full sized wash loads
Half Load Wash	Optimized wash settings for half sized wash loads
Juice and Food Stains	Removes juice and food stains from clothes.
Hand Wash / Wool	For washing shrinkable woolen or hand-washable items requiring delicate care
Overnight Wash	Reduces washing noise and continues tumbling after the cycle to prevent wrinkles.
Perm. Press	Optimized for wrinkle-free clothes or tablecloths.
Rainy Day	Cleans clothing that is damp from the rain.
Rinse+Spin	rinse and spin a load separately from a regular cycle.
Single Garments	Quickly washes a single item.
Small Load	Washes a small load of laundry (less than 3 lb).
Sportswear	Optimized for specially treated sportswear.
Sweat Stains	Removes sweat stains and odor.
Towels	Optimized for towels, shirts, jeans and mixed loads.

Downloaded and Cloud Cycles for the Dryer

Check the **LG ThinQ** app for available Downloaded and Cloud cycles for your model.

Cycle Name	Description
Antibacterial	Reduces 99.9% of bacteria on laundry.
Air Dry	For items that require heat-free drying such as plastics or rubber
Blankets	Dries bulky blankets
Blanket Refresh	Warms blankets and makes them feel nice and fluffy.
Denim	Special cycle for jeans
Deodorization	Reduces odors in clothes that do not require washing.
Easy Ironing	Leaves clothes slightly damp so they're ready to iron dry.

Cycle Name	Description
Full Load Dry	Optimized dry settings for full sized loads
Half Load Dry	Optimized dry settings for half sized loads
Gym Clothes	Optimized for gym clothes.
Kids' Clothes	Uses high temperatures to sanitize kids' clothes.
Kids' Gym Clothes	Optimized for children's cotton sportswear.
Lingerie	Optimized for lingerie.
Low Temp Dry	Dries the load while reducing energy consumption.
Overnight Dry	This energy efficient cycle dries a small load overnight.
Perm. Press	Optimized for permanent press fabrics or synthetic items.
Rack Dry	Designed for use with the drying rack to dry items such as wool sweaters, silk items, or lingerie that should be dried flat.
Rainy Day	Dries clothes made damp by rain or snow.
Socks	Optimized for socks.
Speed Dry	Dries small loads quickly using high temperatures.
Sportswear	Optimized for specially treated sportswear.
Static Reduce	Uses steam to reduce static in dry clothes.
Steam Sanitary	Reduces bacteria on laundry using Turbo Steam.
Super Dry	Thoroughly dries cotton clothes.
Towels	Optimized for towels.
Ultra Delicate	Uses low heat to carefully dry delicate items.
Wrinkle Prevention	Tumbles clothes without heat after the cycle ends to prevent wrinkles caused by leaving clothes in the dryer. To stop, open the dryer door or turn off power to the dryer.

Wireless LAN Module Specifications

Model	LCW-004
Frequency Range	2412 - 2462 MHz
Output Power (Max)	< 30 dBm

FCC Notice

The following notice covers the transmitter module contained in this product.

This equipment has been tested and found to comply with the limits for a Class B digital device, pursuant to Part 15 of the FCC Rules. These limits are designed to provide reasonable protection against harmful interference in a residential installation. This equipment generates, uses, and can radiate radio frequency energy and, if not installed and used in accordance with the instructions, may cause harmful interference to radio communications. However, there is no guarantee that interference will not occur in a particular installation. If this equipment does cause harmful interference to radio or television reception, which can be determined by turning the equipment off and on, the user is encouraged to

try to correct the interference by one or more of the following measures:

- Reorient or relocate the receiving antenna.
- Increase the separation between the equipment and the receiver.
- Connect the equipment to an outlet on a circuit different from that to which the receiver is connected.
- Consult the dealer or an experienced radio/TV technician for help.

This device complies with part 15 of the FCC Rules. Operation is subject to the following two conditions:

(1) This device may not cause harmful interference and

(2) This device must accept any interference received, including interference that may cause undesired operation.

Any changes or modifications in construction of this device which are not expressly approved by the party responsible for compliance could void the user's authority to operate the equipment.

FCC RF Radiation Exposure Statement

This equipment complies with FCC radiation exposure limits set forth for an uncontrolled environment. This transmitter must not be co-located or operating in conjunction with any other antenna or transmitter.

This equipment should be installed and operated with a minimum distance of 20 cm (7.8 inches) between the antenna and your body. Users must follow the specific operating instructions for satisfying RF exposure compliance.

Open Source Software Notice Information

To obtain the source code under GPL, LGPL, MPL, and other open source licenses, that is contained in this product, please visit <http://opensource.lge.com>. In addition to the source code, all referred license terms, warranty disclaimers and copyright notices are available for download.

LG Electronics will also provide open source code to you on CD-ROM for a charge covering the cost of performing such distribution (such as the cost of media, shipping, and handling) upon email request to opensource@lge.com. This offer is valid for a period of three years after our last shipment of this product. This offer is valid to anyone in receipt of this information.

Smart Diagnosis™ Function

Use this feature to help you diagnose and solve problems with your appliance.

NOTE

- For reasons not attributable to LGE's negligence, the service may not operate due to external factors such as, but not limited to, Wi-Fi unavailability, Wi-Fi disconnection, local app store policy, or app unavailability.
- The feature may be subject to change without prior notice and may have a different form depending on where you are located.

Using LG ThinQ to Diagnose Issues

If you experience a problem with your Wi-Fi equipped appliance, it can transmit troubleshooting data to a smartphone using the **LG ThinQ** application.

- Launch the **LG ThinQ** application and select the **Smart Diagnosis™** feature in the menu. Follow the instructions provided in the **LG ThinQ** application.

Using Audible Diagnosis to Diagnose Issues

Follow the instructions below to use the audible diagnosis method.

- Launch the **LG ThinQ** application and select the **Smart Diagnosis™** feature in the menu. Follow the instructions for audible diagnosis provided in the **LG ThinQ** application.

- 1 Press the **Power** button to turn on the appliance.
 - Do not press any other buttons.
- 2 Hold the mouthpiece of your phone in front of the appliance.
 - Washer: Hold the phone to the right of the **Start/Pause** button.
 - Dryer: Hold the phone to the left of the **Power** button.

36 SMART FUNCTIONS

- 3** Press and hold the **Steam + Extra Rinse** (Washer) / **Steam + Reduce Static** (Dryer) buttons for **3 seconds** or until the audible tones start. Hold the smartphone mouthpiece to the logo until the data transfer is complete.
 - Keep the smartphone in place until the data transfer has finished. Time remaining for data transfer is displayed.

- 4** After the data transfer is complete, the diagnosis will be displayed in the application.

NOTE

- For best results, do not move the smartphone while the tones are being transmitted.
-

MAINTENANCE

WARNING

- To reduce the risk of fire, electric shock, or injury to persons, read this entire owner’s manual, including the SAFETY INSTRUCTIONS, before operating this appliance.
- Unplug the appliance before cleaning to avoid the risk of electric shock. Failure to follow this warning can cause serious injury, fire, electric shock, or death.
- Do not use volatile substances (benzene, paint thinner, alcohol, acetone, etc.), abrasive cleaners, or detergents with strong chemical components when cleaning the appliance. Doing so may cause discoloration or damage to the appliance, or may cause a fire.
- Certain internal parts are intentionally not grounded and may present a risk of electric shock only during servicing. Service personnel - Do not contact the following parts while the appliance is energized: pump, valve, motor, control board.

Washer

Regular Cleaning

Care after Wash

After the cycle is finished, wipe the door and the inside of the door seal to remove any moisture.

- Wipe the body of the washer with a dry cloth to remove any moisture.
- Leave the door open to dry the drum interior.

WARNING

- Make sure children and pets do not climb into the drum. Engage the **Control Lock** feature if needed to prevent children from accidentally starting a wash cycle.

Cleaning the Exterior

Proper care of your washer can extend its life.

Door:

Wash with a damp cloth on the outside and inside and then dry with a soft cloth.

Exterior:

- Immediately wipe off any spills.
- Wipe with a damp cloth.
- Do not touch the surface or the display with sharp objects.

Cleaning the Drum

Over time, residue may build up in the drum, leading to mildew or a musty odor. Run the **Tub Clean** cycle **monthly** to remove residue and prevent odor.

NOTE

- Make sure to run the **Tub Clean** cycle only when the drum is empty. Never load laundry while using this cycle. The laundry may be damaged or contaminated with cleaning products.
- Run the cycle more often under heavy use conditions or if odor is already present.
- If mildew or musty smell already exists, run this cycle once a week for three consecutive weeks.

1 Remove any clothing from the drum.

2 Add cleaning agents.

Cleaner	Instructions
Drum cleaner	Add to main detergent compartment of detergent dispenser
Lime scale remover	
Liquid chlorine bleach	Add to bleach compartment of detergent dispenser.
Powdered cleaner	Pull out liquid detergent cup before adding to main detergent compartment
Cleaning tablets	Place directly into the washer drum.

38 MAINTENANCE

- For other drum cleaning products, follow the cleaner manufacturer's instructions and recommendations.
- Do not exceed the maximum fill line when adding bleach or powdered cleaners. Powdered cleaners may remain in the drum after cleaning.

3 Close the door and press the **Power** button.

4 Select the **Tub Clean** cycle and press the **Start/Pause** button to begin the cycle.

5 After the cycle ends, open the door and allow the drum interior to dry completely.

⚠ WARNING

- Make sure children and pets do not climb into the drum. Engage the **Control Lock** feature if needed to prevent children from accidentally starting a wash cycle.

NOTE

- If you use a descaler or drum cleaner during the **Tub Clean** cycle, use the **Speed Wash** option to rinse the washer drum before running your next wash cycle.

Automatic Alert for Tub Clean

When the power is on and the **CL** message blinks on the display, it means the washer drum needs cleaning. Use the **Tub Clean** cycle to clean the washer drum. The frequency of the automatic alert's appearance depends on how often the washer is used. However, the message will generally appear every one to two months.

Removing Mineral Buildup

In areas with hard water, mineral scale can form on internal components of the washer. Periodically clean the mineral buildup on the internal components to extend the lifespan of the washer. Use of a water softener is recommended in areas with hard water.

- Use a descaler to remove visible mineral buildup on the washer drum.
- After descaling, always run the **Tub Clean** cycle before washing clothing.

- Mineral scale and other spots may be removed from the stainless steel drum using a soft cloth soaked in stainless steel cleaner.
- Do not use steel wool or abrasive cleaners.

Leaving the Door Open

After you finish using the washer, leave the door open overnight to allow air to circulate and dry the drum. This helps prevent odors.

Cleaning the Dispenser Drawer

Leaving detergent in the detergent dispenser drawer for an extended period of time or using the washer for a long period of time may cause the build-up of residue in the detergent dispenser drawer. Remove and clean the detergent dispenser drawer **once or twice a month**.

⚠ WARNING

- Do not spray water inside the washer. Doing so may cause fire or electric shock.

1 Turn off the washer, and unplug the power cord.

2 Pull the drawer straight out until it stops.

3 Press down hard on the disengage button **1** and pull the drawer completely out.

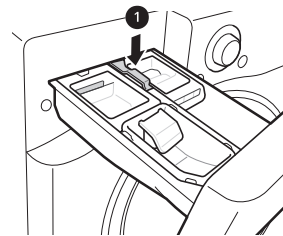

4 Remove the inserts from the drawer.

5 Clean the inserts and drawer with warm water.

- Use a soft cloth or brush to clean and to remove any residue.
- Do not use soap when cleaning the drawer and inserts.

6 Wipe off any moisture with a dry towel or cloth after cleaning.

- 7 To clean the drawer opening, use a small, non-metal brush to clean the recess. Remove all residue from the upper and lower parts of the recess.
- 8 Replace the drawer.

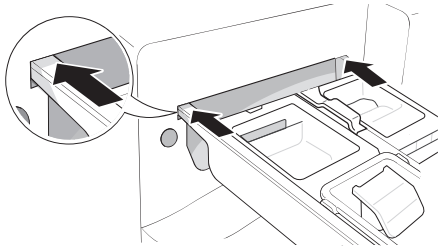

Cleaning the Door Seal

Clean the door seal **once a month** to prevent build-up of dirt.

⚠ CAUTION

- Cleaning the door seal with undiluted bleach may cause malfunction of the door seal and washer parts. You must add water to the bleach before using it.

- 1 Wear rubber gloves and protective goggles.
- 2 Dilute 3/4 cup (177 mL) of liquid chlorine bleach in 1 gallon (3.8 L) of water.
- 3 Wipe around the door seal.
 - Soak a sponge or a soft cloth in this diluted solution and wipe all around the door seal.
- 4 Wipe up any moisture with a dry towel or cloth after cleaning.
- 5 Leave the door open to allow the door seal to dry completely.

Cleaning the Water Inlet Filters

If the washer does not fill properly, an error message will appear on the display. The inlet valve filter screens could be clogged by hard water scale, sediment in the water supply, or other debris.

⚠ WARNING

- The inlet screens protect the delicate parts of the inlet valve from being damaged by particles that could enter the valves with the water supply. Operating the washer with these filters removed could cause a valve to open continuously, resulting in flooding and/or property damage.

⚠ CAUTION

- Do not use the washer without the inlet filters. Doing so will cause leaks and malfunction.
- If you use the washer in an area with hard water, the inlet filter may clog due to lime buildup and require more frequent cleaning.

- 1 Turn off the washer, and unplug the power cord.
- 2 Turn off hot and cold water faucets.
- 3 Unscrew the hot and cold water hoses from the back of the washer.
- 4 Remove the filters from the water valves carefully.
 - Use pliers to pull out the filters from the water valves.

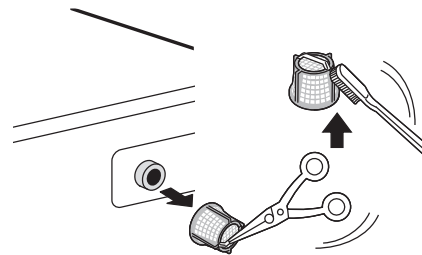

- 5 Remove foreign objects and soak the filters in white vinegar or a lime scale remover.
 - If using a lime scale remover, follow the manufacturer's instructions. Be careful not to damage the filters while cleaning them.
- 6 Rinse filters thoroughly and press them back into place.

- 7** Flush then reattach the water hoses.
- Before reattaching the water inlet hoses, flush them by running several gallons of water through them into a bucket or drain, preferably with the faucets wide open for maximum flow.

NOTE

- An I E error message may blink on the display when the water pressure is low or an inlet filter is clogged with dirt. Clean the inlet filter.

Cleaning the Drain Pump Filter

The washer fails to drain if the drain pump filter is clogged. Periodically clean the drain filter to prevent clogging with foreign objects.

⚠ WARNING

- Opening the drain filter will result in water overflowing if there is water in the drum. Use a bucket if the drum is not completely drained before you open the drain filter.
- Using the washer without the drain filter or with an incorrectly assembled drain filter may cause leaks or malfunction of the washer.

- 1** Turn off the washer, and unplug the power cord.
- 2** Open the drain pump filter cover.

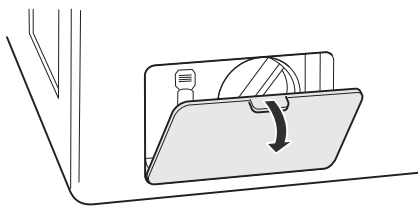

- 3** Drain any remaining water.
- Unclip the drain hose and remove the plug from the drain hose to drain the remaining water.

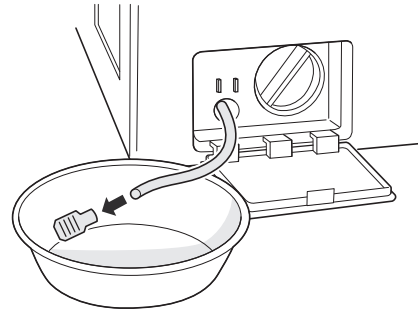

- 4** Remove the pump filter.
- Twist the pump filter counterclockwise to remove.

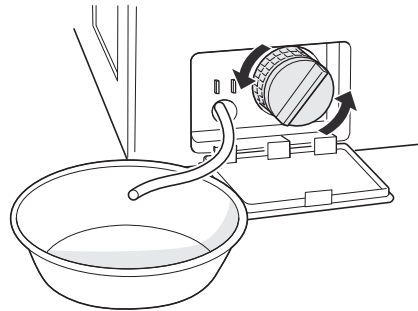

- 5** Clean the pump filter and opening.

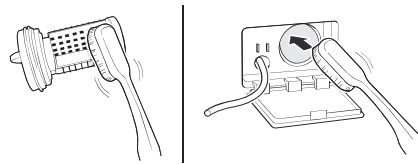

- 6** Reassemble the plug onto the drain hose and reclip the drain hose.

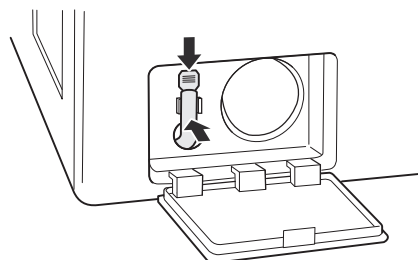

- 7** Insert the drain pump filter and twist it clockwise.

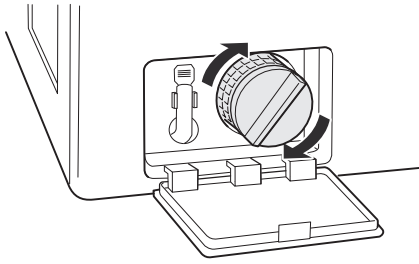

8 Close the drain pump filter cover.

NOTE

- An **UE** message blinks on the display when the drain pump filter is clogged with dirt. Clean the drain pump filter.

Care in Cold Climates

Storing the Appliance

If the washer will not be used for an extended period of time and is in an area that could be exposed to freezing temperatures, follow these steps to protect the washer from damage.

NOTE

- Make sure the drum is empty before following these steps.

- 1** Turn off the washer, and unplug the power cord.
- 2** Turn off the water faucets.
- 3** Disconnect the water inlet hoses. Drain any water from the hoses.

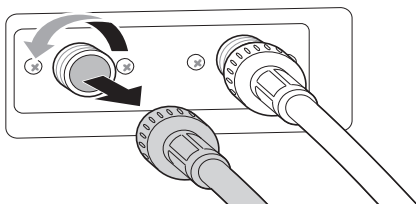

4 Plug the power cord into a properly grounded electrical outlet.

5 Add 1 gallon of nontoxic recreational vehicle (RV) antifreeze to the empty drum and close the door.

- Never use automotive antifreeze.

6 Turn on the washer and press the **Spin** button.

7 Press the **Start/Pause** button to start the drain pump for **1 minute**.

- This will expel some of the antifreeze, leaving enough to protect the washer from damage.

8 Turn off the washer and unplug the power cord.

9 Dry the drum interior with a soft cloth, and close the door.

10 Store the washer in an upright position.

11 Remove the inserts from the dispenser. Drain any water in the compartments and let them dry.

12 To remove the antifreeze from the washer after storage, run the **Speed Wash** cycle using detergent.

- Do not add laundry to this cycle.

When the Water Inlet Hoses Are Frozen

1 Turn off the washer, and unplug the power cord.

2 Turn off the faucets connected to the water inlet hoses.

3 Pour hot water on the frozen faucets to thaw the water inlet hoses and remove the water inlet hoses.

4 Immerse the water inlet hoses in hot water to thaw them.

42 MAINTENANCE

- 5** Reconnect the water inlet hoses to the water inlets of the washer and to the faucets.
 - See **Connecting the Water Inlet Hoses** for details.
- 6** Turn on the faucets.
- 7** Press the **Power** button to turn on the washer.
- 8** Press the **Spin** button to operate spin only cycle for draining and spinning.
- 9** Press the **Start/Pause** button.

When the Drain Hose is Frozen

- 1** Pour hot water in the washer drum and close the door.
- 2** Wait for **1 - 2 hours**.
- 3** Press the **Power** button.
- 4** Press the **Spin** button to operate spin only cycle for draining and spinning.
- 5** Press the **Start/Pause** button to make sure the water drains.

Dryer

Regular Cleaning

Cleaning the Exterior

Proper care of your appliance can extend its life. The outside of the appliance can be cleaned with warm water and a mild, nonabrasive household detergent. Immediately wipe off any spills with a soft, damp cloth.

NOTE

- Do not use methylated spirits, solvents, or similar products.
 - Never use steel wool or abrasive cleansers; they can damage the surface.
-

Cleaning the Interior

- Wipe around the door opening and seal with a soft, damp cloth to prevent lint and dust buildup that could damage the door seal.
- Clean the window with a soft cloth dampened with warm water and a mild, nonabrasive household detergent. Then wipe dry.
- The stainless steel drum can be cleaned with a conventional stainless steel cleaner, used according to the manufacturer's specifications. Never use steel wool or abrasive cleansers; they may scratch or damage the surface.

Cleaning Around and Under the Appliance

Vacuum lint and dust from around the dryer and underneath it regularly.

Maintaining Ductwork

Vent ductwork should be checked for lint build up once per month and cleaned at least once per year. If any noticeable reduction in airflow or drying performance occurs, immediately check ductwork for obstructions and blockages and contact a qualified technician or service provider.

Cleaning the Lint Filter

Always clean the lint from the filter after every cycle.

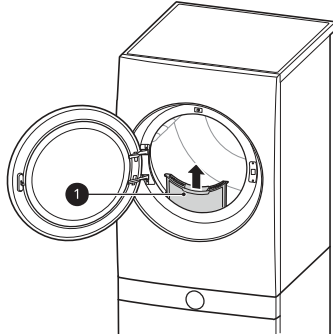

1 Lint Filter

To clean the lint filter, open the dryer door and pull the lint filter straight up. Then:

- 1 For everyday cleaning, roll any lint off the filter with your fingers, or

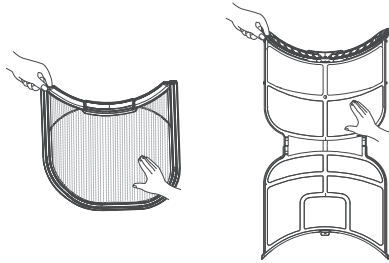

- 2 Vacuum the lint filter.

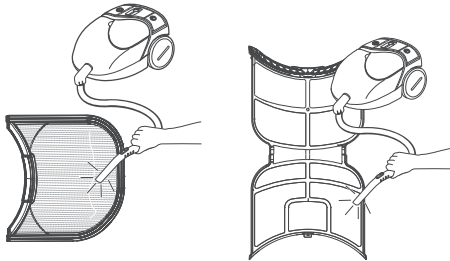

- 3 If the lint filter has become very dirty or clogged with fabric softener, wash the lint filter in warm, soapy water and allow it to dry thoroughly before reinstalling.

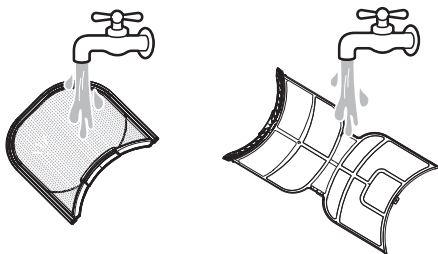

NOTE

- NEVER operate the appliance without the lint filter in place.